

# 4381LTCTK SUMMIT® 1.28



Complete Toilet Kit, Round Front, Vitreous China, Two-Piece Toilet

## FEATURES

- Complete toilet kit (CTK) with tank liner
- High performance MagnaFlush™ flushing technology
- SmartFasten™ 3-bolt tank-to-bowl connection
- 1.28 gpf / 4.8 lpf high efficiency water consumption
- Round front bowl
- PuraClean® easy-to-clean glaze
- Fluidmaster® pilot operated anti-siphon fill valve
- 3" Rigid Flapper flush valve – requires less force to flush, is more consistent and uses a simple universal repair part/seal
- Model 57 chrome-plated, metal trip lever
- 12" rough-in
- 2" glazed trapway
- The Mansfield® limited lifetime warranty on china;  
Five-year limited warranty on tank trim
- Available in White



**MODEL 4381LTCTK**

Toilet seat included

Complete toilet kit





ROUND



CTK

## COMPONENTS

MODEL #	DESCRIPTION	CODES/STANDARDS
4381LTCTK	Round front, two-piece toilet kit. Includes: toilet seat, wax toilet ring, floor bolts, caps, and multi-lingual installation instructions. Water supply hardware not included.	  
380	Round front toilet bowl only. Less toilet seat.	
387LT	Tank and cover only, with left hand, front-mount, chrome-plated, metal trip lever. Tank liner. Less supply.	
3700	Round, slow close CTCK seat	
TANK TRIM & REPLACEMENT PARTS		
57	Trip lever - chrome-plated, metal trip lever, left hand	
2036-1212	Summit® 1.28 rigid flapper flush valve	
400A	Fluidmaster® anti-siphon pilot fill valve	
2206	Anti-siphon pilot fill valve (compatible replacement)	
630-0030	Replacement flush valve seal	
386-LID	Tank lid	





# 4381LTCTK SUMMIT® 1.28



Complete Toilet Kit, Round Front, Vitreous China, Two-Piece Toilet

## SPECIFICATIONS

MODEL #	DESCRIPTION	CODES/STANDARDS
4381LTCTK	Round front, (1.28 gpf/4.8 lpf) two-piece toilet kit	  

MATERIAL	Vitreous China
WATER PRESSURE RANGE	20 to 80 PSI
FLUSH SYSTEM	MagnaFlush™ flushing technology
WATER USAGE	1.28 gpf / 4.8 lpf
WATER SURFACE AREA	8' X 9'
ROUGH-IN	12'
MAP RATING	1,000 grams

TRAP DIAMETER	2'
TRAP SEAL	2-3/8'
SHIPPING WEIGHT	Model 4381LTCTK - 91 lbs. (41.2 kg)
WARRANTY	Vitreous China - Limited Lifetime Tank Trim - Limited Five Year

## TECHNICAL INFORMATION

**Note:** these dimensions are nominal and subject to change without notice.

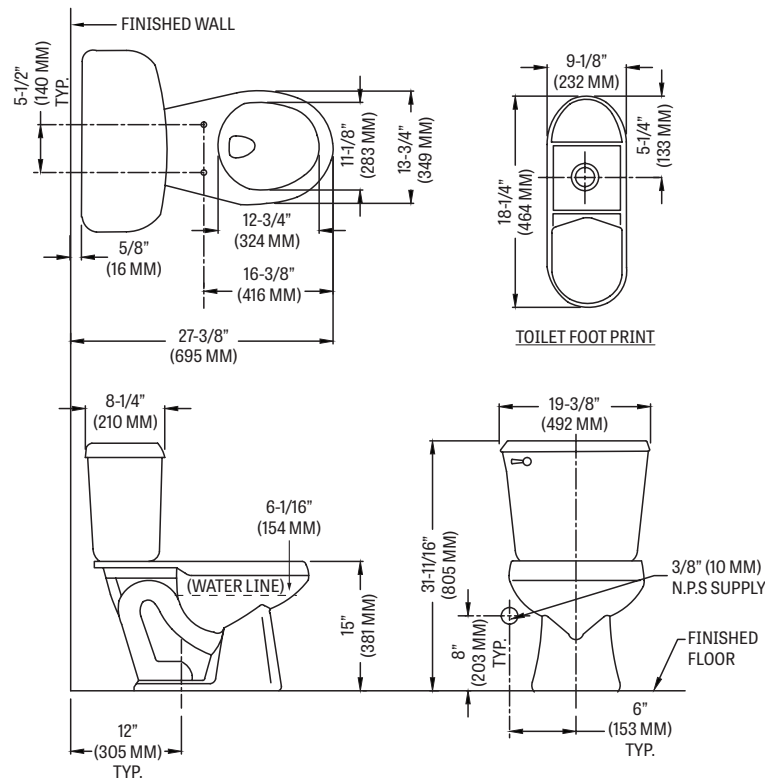

Fixture performance and specifications meet or exceed ASME A112.19.2/CSA B45.1 standards, and other state and local codes.

